

Product datasheet

Specifications



Harmony XAP, XB2 SL, Empty control station, zinc alloy, grey, M20, 1 cut-out 22mm, 80 x 80 x 77, UL cULus

XAPD1501

EAN Code : 3389110001044

Main

Range of product	Harmony XAP
Product or component type	Die-cast empty control station
Device short name	XAPD
Product destination	For Ø 22 mm control and signalling units
Product front plate size	80 x 80 mm
Usable depth	74.5 mm
Number of cut-out	1 cut-out
Colour of base of enclosure	Grey (RAL 7035)
Colour of cover	Grey (RAL 7035)
Material	Die cast zinc
Sale per indivisible quantity	1
IP degree of protection	IP65 conforming to EN/IEC 60529 and EN/IEC 60947-5-1 IP66 conforming to EN/IEC 60529 and EN/IEC 60947-5-1 IP69 conforming to EN/IEC 60529 and EN/IEC 60947-5-1

Complementary

Number of vertical rows	1
Number of horizontal rows	1
Cut-out dimensions	Ø 22 mm
Control station type	Metal
Cable entry	2 x cable gland conforming to ISO
Thread type	M20 x 1.5
CAD overall width	80 mm
CAD overall height	80 mm
CAD overall depth	77 mm
Net weight	0.605 kg

Environment

Protective treatment	TC
----------------------	----

Ambient air temperature for storage	-40...70 °C
Ambient air temperature for operation	-25...70 °C
Electrical shock protection class	Class I conforming to EN/IEC 61140
Degree of protection	UL type 4 conforming to UL 50 E UL type 4X conforming to UL 50 E
IK degree of protection	IK07 conforming to EN/IEC 62262
Resistance to chemical agents	Special treatment can be obtained on request
Product certifications	UL cULus EAC

Packing Units

Unit Type of Package 1	PCE
Number of Units in Package 1	1
Package 1 Height	9.400 cm
Package 1 Width	8.500 cm
Package 1 Length	9.000 cm
Package 1 Weight	796.0 g
Unit Type of Package 2	S02
Number of Units in Package 2	12
Package 2 Height	15.000 cm
Package 2 Width	30.000 cm
Package 2 Length	40.000 cm
Package 2 Weight	9.700 kg
Unit Type of Package 3	P06
Number of Units in Package 3	192
Package 3 Height	75.000 cm
Package 3 Width	60.000 cm
Package 3 Length	80.000 cm
Package 3 Weight	165.776 kg

Offer Sustainability

Sustainable offer status	Green Premium product
REACH Regulation	REACH Declaration
REACH free of SVHC	Yes
EU RoHS Directive	Pro-active compliance (Product out of EU RoHS legal scope) EU RoHS Declaration
Mercury free	Yes
China RoHS Regulation	China RoHS declaration
RoHS exemption information	Yes
Environmental Disclosure	Product Environmental Profile

Contractual warranty

Warranty	18 months
----------	-----------

Dimensions and Fixing

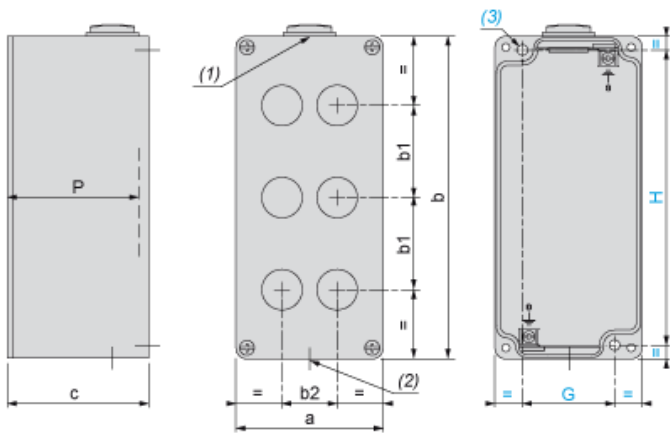

- (1) : 1 hole, with blanking plug (protrusion 6 mm/0.24 in.), for cable gland ISO M20 x 1.5
- (2) : 1 hole, without blanking plug, for cable gland ISO M20 x 1.5
- (3) : 2 x Ø 5.6 mm/0.22 in. holes, depth 19 mm/0.75 in.
- P : Usable depth

a		b		c		G		H		P	
mm	in.	mm	in.	mm	in.	mm	in.	mm	in.	mm	in.
80	3.15	80	3.15	77	3.03	50	1.97	65	2.56	74.5	2.93

1 hole in the center, Cut-out interaxis 22.5 mm ±0.2 mm / 0.885 in. ± 0.0078 in. dimensions (vertical mounting)

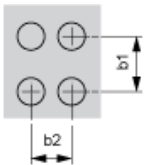

- b1 Vertical interaxis: In the center of the box
- b2 Horizontal interaxis: In the center of the box

Recommended replacement(s)